



The role of trace constituents for the sustained operation of corona discharges in APCI



Physical & Theoretical Chemistry
Wuppertal, Germany
(Institute for Pure and Applied Mass Spectrometry)

Florian Stappert; Steffen Braekling; Hendrik Kersten; Thorsten Benter

Introduction

A classical but still important method to create ions for analytical applications using mass spectrometry (MS) or ion mobility spectrometry (IMS) is the application of corona plasmas. This discharge type is operating favorably at atmospheric pressure; thus virtually all commercial atmospheric pressure ionization (API) mass spectrometers feature an ion source, which is relying on this type of plasma (APCI source).

Coronas are point to plane discharges generated by a strong electric field gradient at a needle electrode, and are characterized by a low gas but high electron temperature.^[1] Corona discharges can be recognized visually by a faint glow around the tip electrode. Previous results show a high sensitivity towards physical changes of the tip.^[2]

Generally, coronas are generating primary ions (e.g. N_2^+ and/or H_2O^+), which protonate the analyte (see *ion source*).^[3] The purpose of the custom ion source used in the experiments presented here is to generate H_3^+ as reactant ion species.^[2] To suppress charge loss and clustering reactions, a "water free" environment in the ion source is mandatory.

Previous experiments showed that LN_2 cold traps positioned closely upstream of the source entrance in the N_2 gas supply line resulted in periodical disruptions of the corona.^[3] This behavior is investigated further in detail in this contribution.

Methods

MS System: 3200 Triple Quad™ (SCIEX), with custom ion source
GC: 7890A GC System (Agilent), with custom transferline
Flow controller: EL-FLOW® Select (Bronkhorst)
Gases: boil-off nitrogen (Linde AG) hydrogen, helium (5.0, Messer Griesheim)

- typical gas flows of 800 ml/min (nitrogen), 1 ml/min (hydrogen) and 2 ml/min (helium)
- Discharge voltage between 7.8 and 8.2 kV

Ion source

- 1) $N_2 + e^- \rightarrow N_2^+ + 2 e^-$
- 2) $N_2^+ + 2N_2 \rightleftharpoons N_4^+ + N_2$
- 3) $N_2^+ + H_2O \rightarrow N_2H^+ + OH$
- 4) $N_2H^+ + H_2O \rightarrow H_3O^+ + N_2$
- 5) $N_2^+ + H_2O \rightarrow H_2O^+ + N_2$
- 6) $N_4^+ + H_2O \rightarrow H_2O^+ + 2N_2$
- 7) $H_2O^+ + H_2O \rightarrow H_3O^+ + OH$
- 8) $H_3O^+ + H_2O + N_2 \rightleftharpoons [H+(H_2O)_2]^+ + N_2$
- 9) $[H+(H_2O)_{n-1}]^+ + H_2O + N_2 \rightleftharpoons [H+(H_2O)_n]^+ + N_2$

Figure 1: Reaction mechanism for creating proton bound water clusters as primary charge carriers with energetic electrons e^- from corona discharges.^{[4][5]}

The reagent ion production of classical APCI is initiated with energetic electrons e^- and results in proton bound water clusters $[H+H_2O_n]^+$ ($n=1, 2, \dots$).

Up to six needle electrodes can be mounted to surround the MS-inlet. Hydrogen is added to the main gas flow to generate H_3^+ as reagent ions.

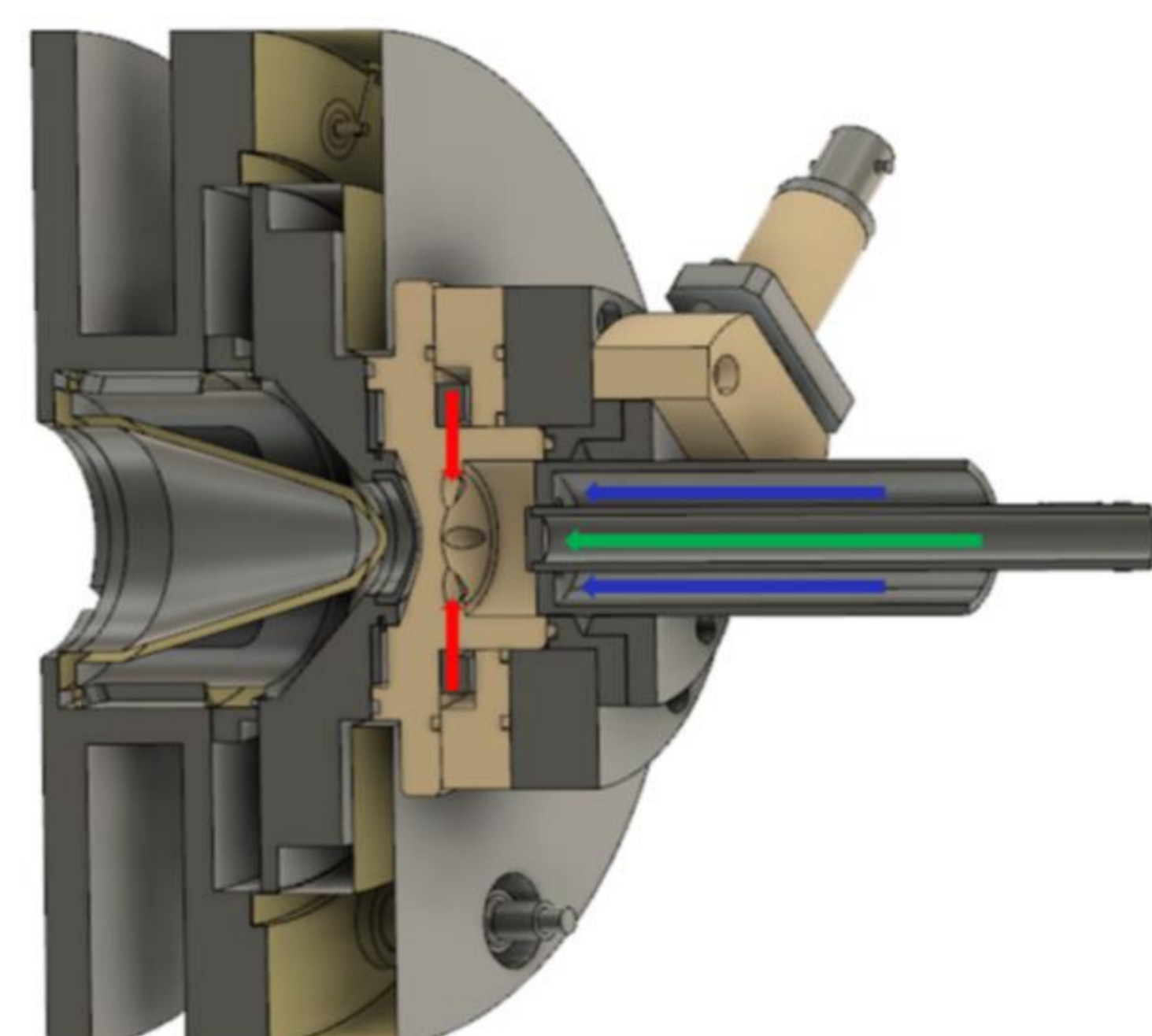

Figure 2: Schematic of the custom multiple-corona ion source with coupled GC-transfer line. Red: Hydrogen; blue: Nitrogen; green: Helium (from GC Column)^[2]

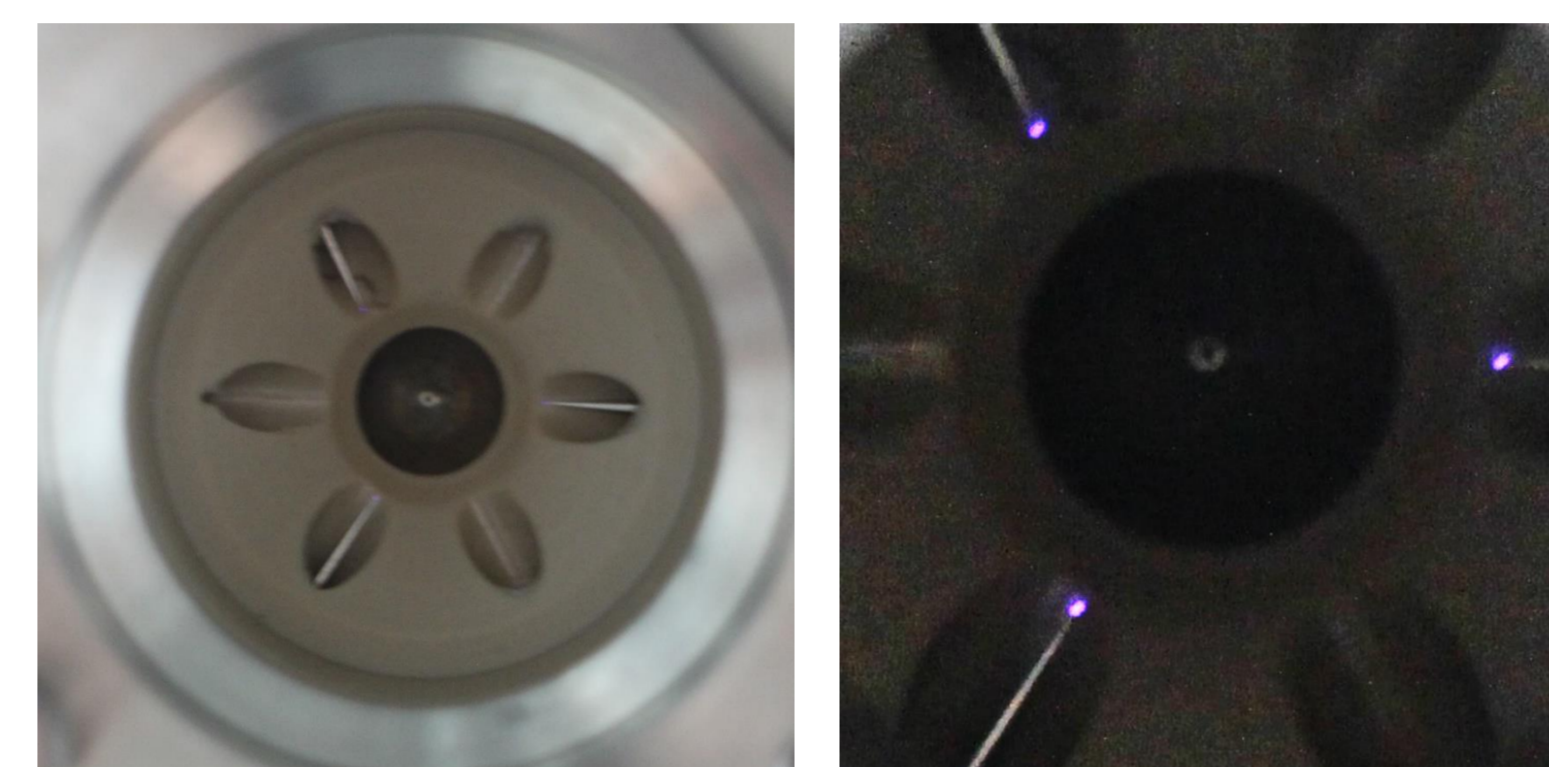

Figure 3: Position of the (here three) corona needles (left) and observation of the corona discharges in laboratory air (right)

Previous results showed the best performance when using three needles which are positioned in a triangular geometry.^[2]

To create a more controllable atmosphere in the ion source, the GC-transfer line can be removed while the source is sealed. Highest purity nitrogen is added via the needle mounts (red arrow) into the source.

Water dependence of corona discharges

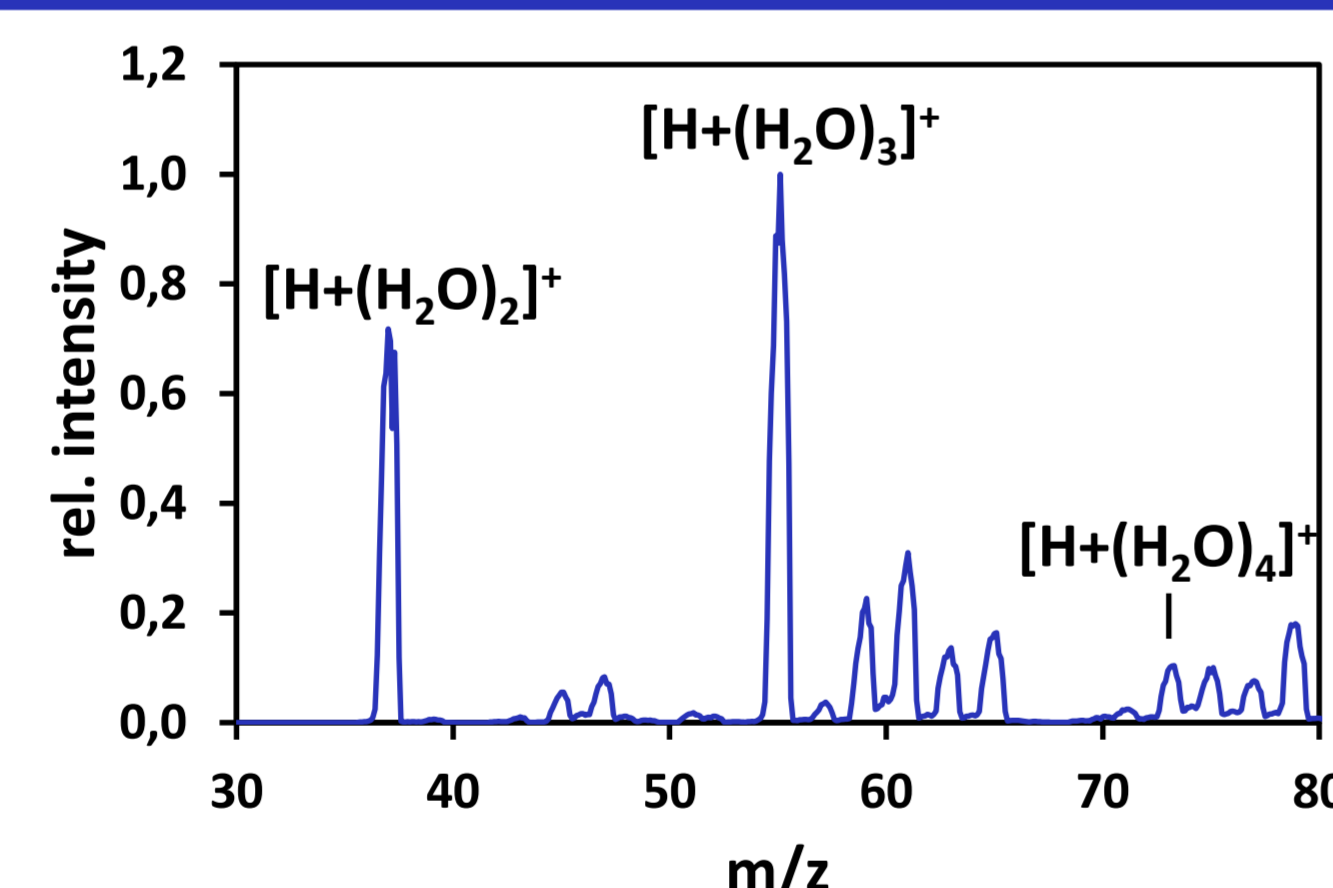

Figure 6: Background spectra with attached transfer line

LN_2 cold trap cooling of the ion source gas feed caused repeated "drop-outs" of the ion current, which indicates disruptions of the corona discharge mode (figure 7.)

The transfer line leads to elevated water mixing ratios in the source, as indicated by the third water cluster as main signal.

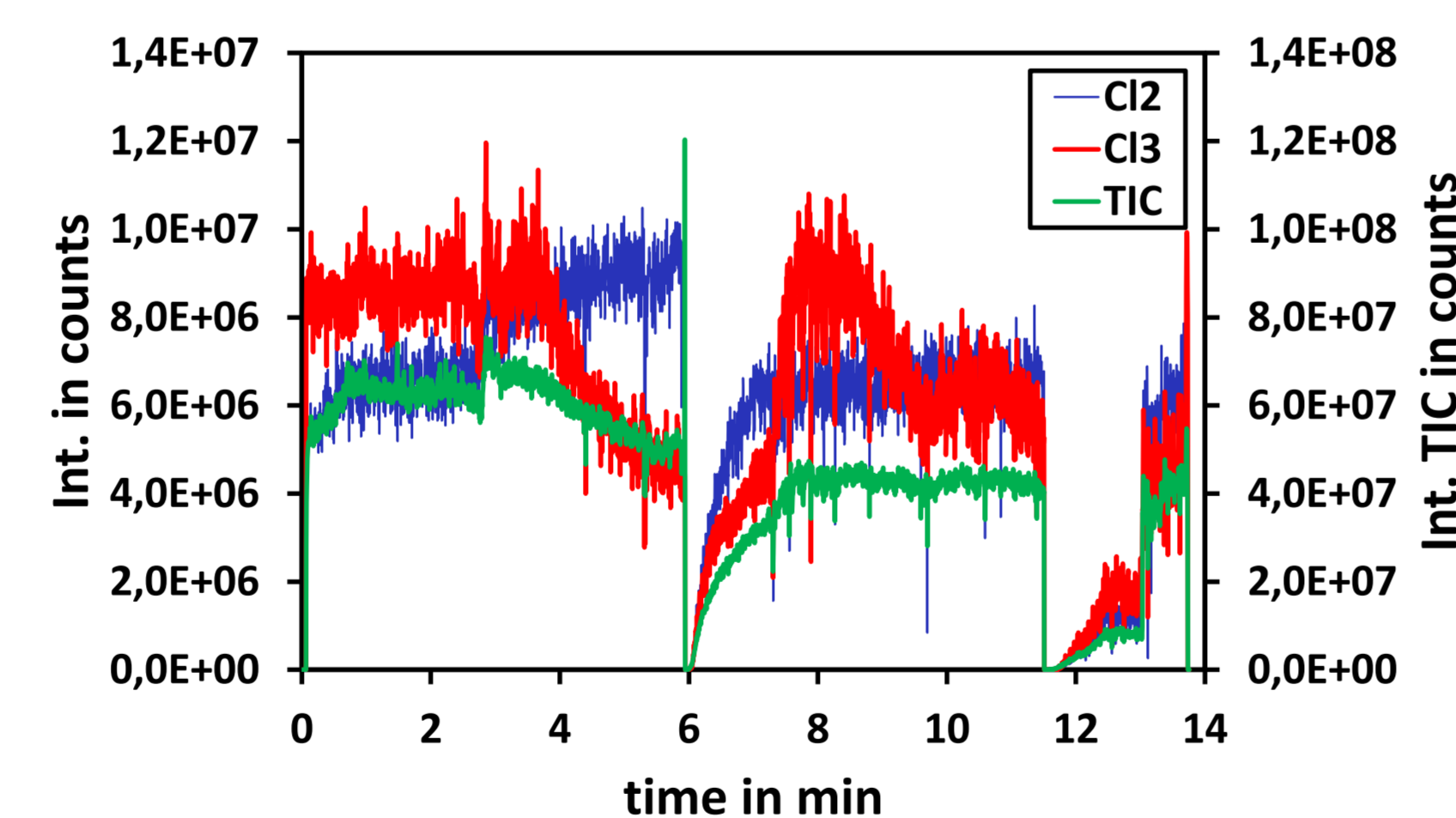

Figure 7: Temporal signal evolution of the second (CI2) and third water cluster (CI3) and total ion current (TIC) with attached transfer line. LN_2 cold trap attached after 3 min run time.



Even without the LN_2 cold trap the water mixing ratio in the sealed ion source is much lower than with attached transfer line.

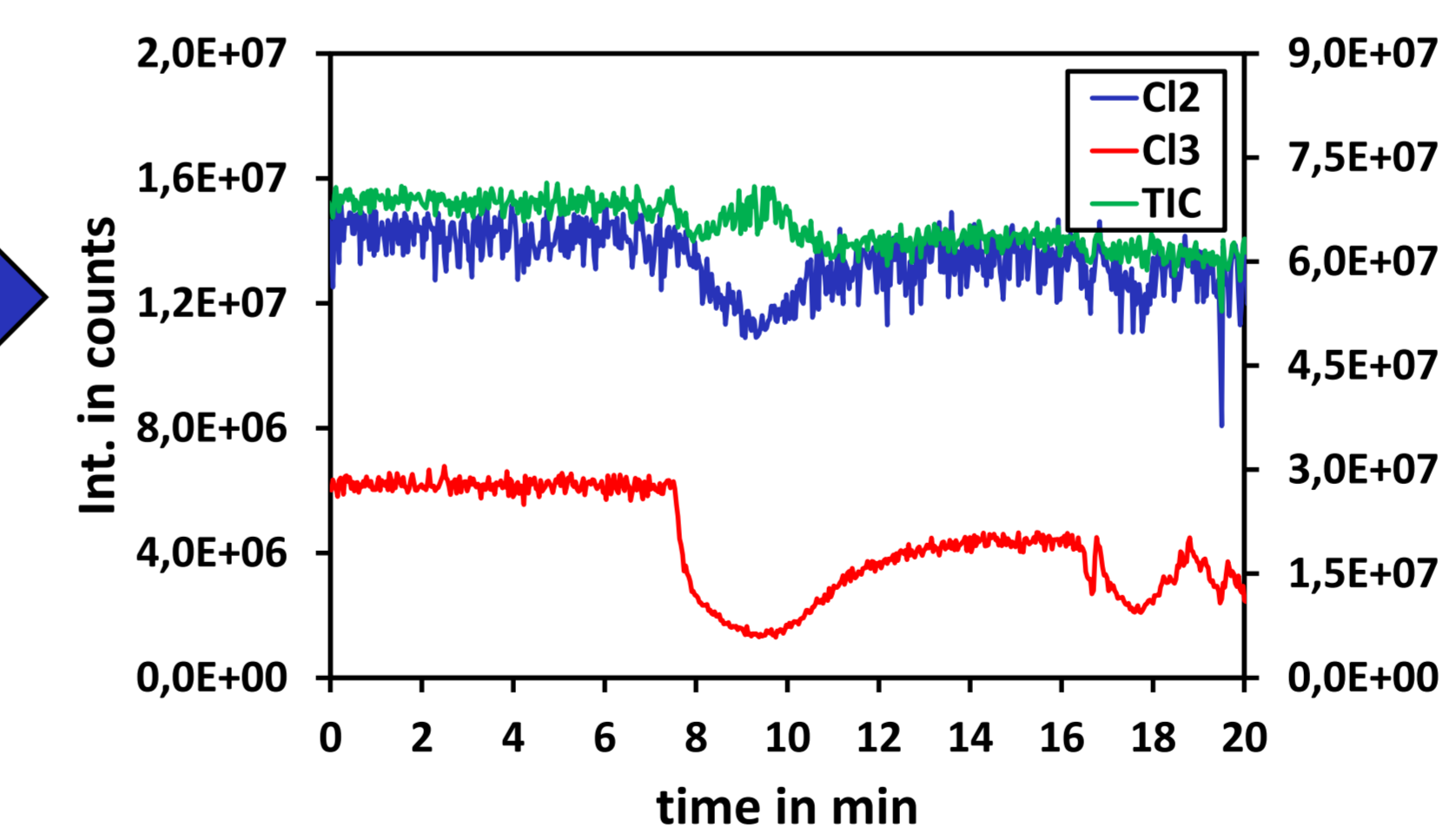

Figure 8: Temporal signal evolution of the second and third water cluster (CI2/CI3) and total ion current (TIC) with LN_2 cold trap attached at about 7 min run time. Sealed ion source only

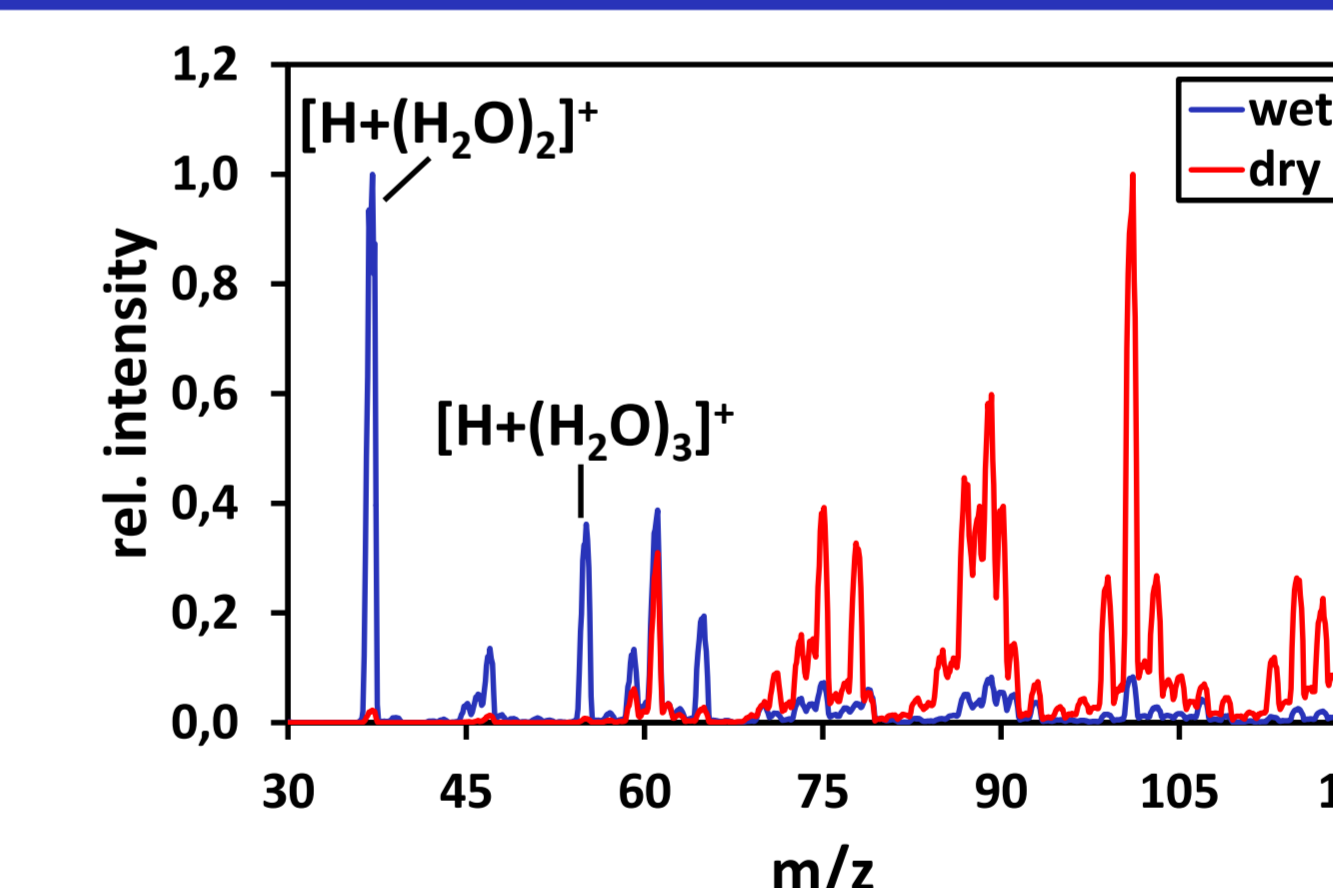

Figure 9: Background mass spectra with sealed ion source using "wet" (red) and "dry" (LN_2 cold trap; blue) nitrogen

After optimizing the setup, the corona discharge is operating even at very low water mixing ratios. Also note the strongly reduced signal fluctuations.

Explanation of discrepancy

Table 1: Differences in setups and their performance

Previous setup/observations	New setup/observations
transfer line attached to source	sealed ion source only
three different matrix gases	nitrogen only
needles at preliminary position in source	sharpened needles at optimized position in source
strong fluctuations	constant performance
high pressure dependence of signal strengths	signals insensitive towards small source pressure changes

Coronas tend to spark when the ambient pressure drops below threshold. This effect is strongly amplified by needle tip corrosion and/or unfavorable positioning of the needle.

By placing an LN_2 cold trap in the main N_2 gas feed line closely to the corresponding flow controller, the gas attains very low

temperatures. This in turn affects the stable operation of the flow controller and leads to flow fluctuations of about +/- 10 %, which has a pronounced effect on the pressure in the discharge region.

Thus sparking occurs, regardless of the background water concentration present.

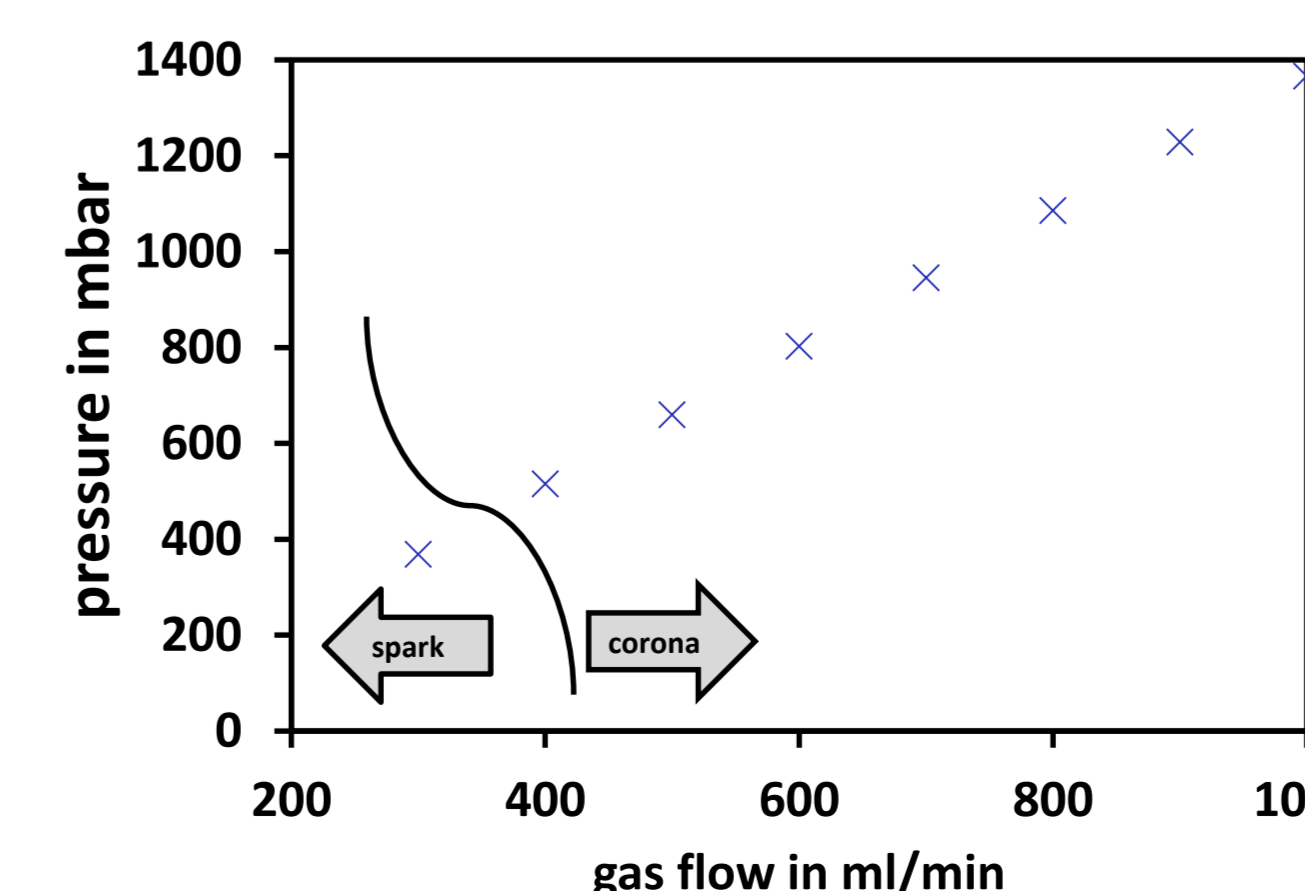

Figure 10: Ion source pressure in dependence of the applied gas flow in the sealed ion source

"Science, my lad, is made up of mistakes, but they are mistakes which it is useful to make, because they lead little by little to the truth."

Jules Verne

Water cluster system

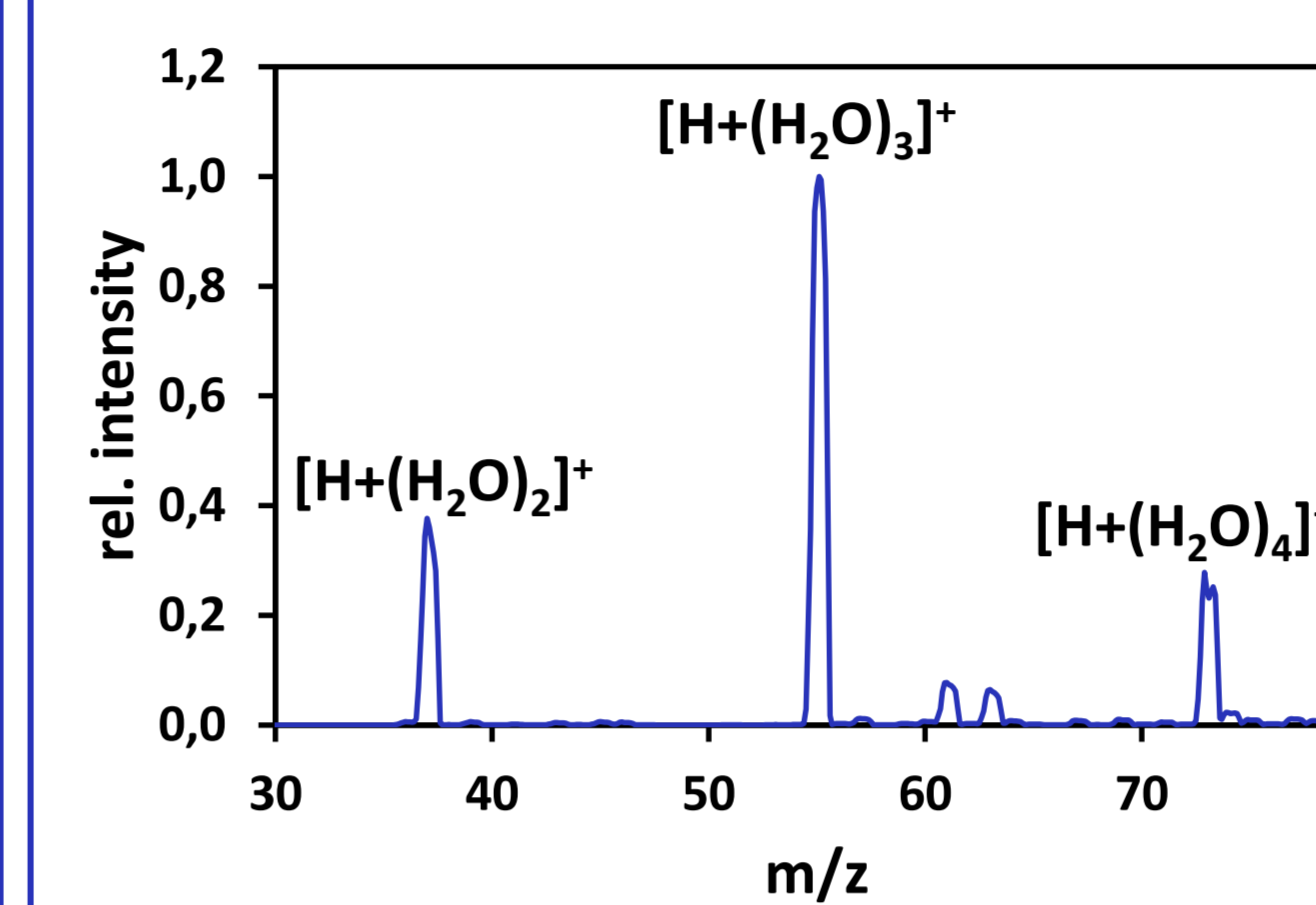

Figure 4: Water cluster distribution (6500 Triple Quad (Sciex))

The cluster distribution and the mean cluster size depend on the water mixing ratio (see figure 5). Thus, the observed cluster distribution can be utilized to estimate the water concentration in the ion source, as long as other parameters are held constant.

Initial charge transfer from N_2^+ to H_2O and subsequent reactions with water forms proton bound water clusters (see figure 4). Note that this spectrum was measured with a different (but comparable) setup and a commercial APCI-source.

Note that this spectrum was measured with a different (but comparable) setup and a commercial APCI-source.

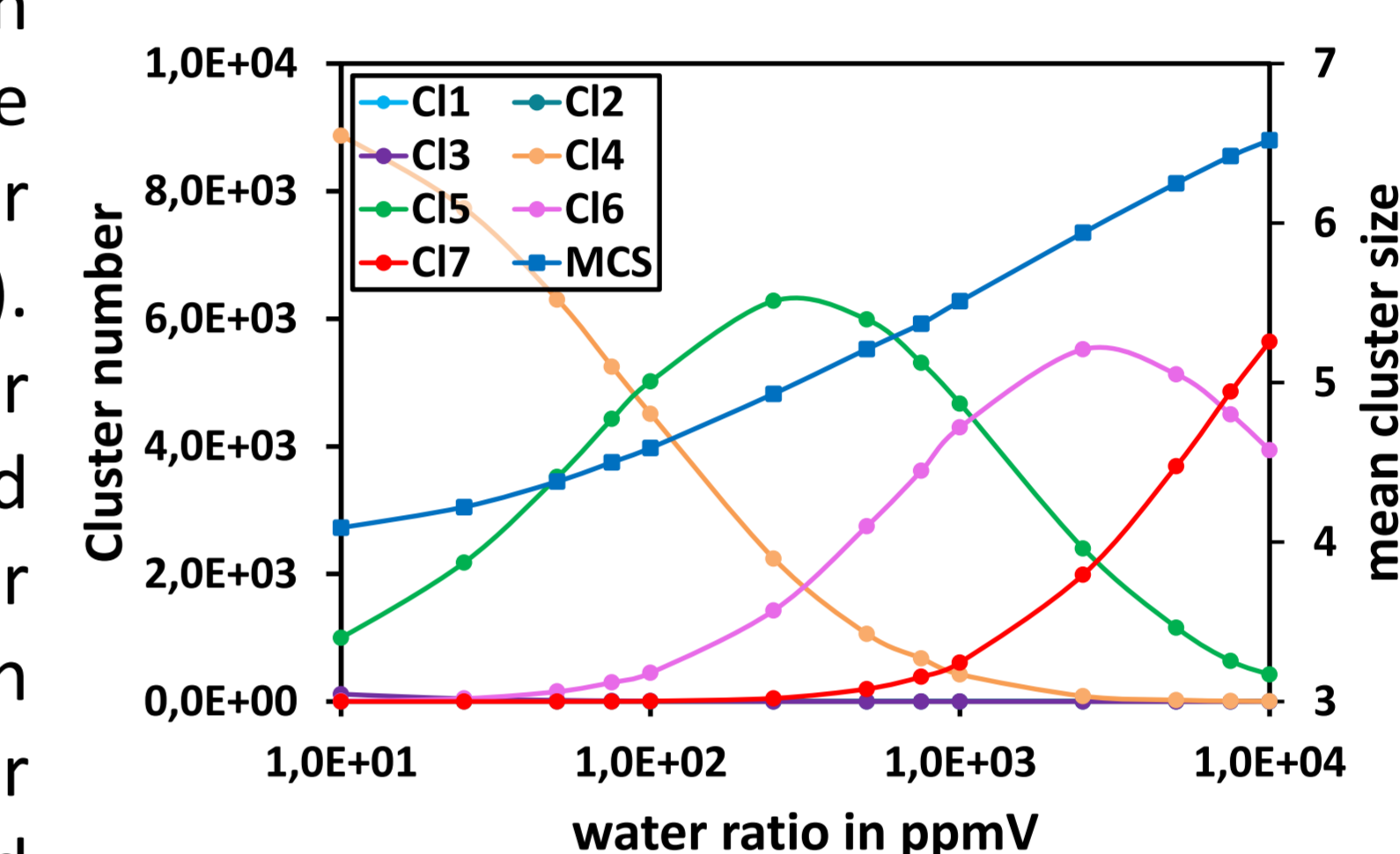

Figure 5: Simulated cluster distribution and mean cluster size at standard conditions in dependence of the water mixing ratio

Conclusions

- LN_2 cooling of the main gas line may adversely affect the performance of a corona discharge.
- This is however *not* the result of drying or cleaning the gas feed.
- The observed signal drop outs and fluctuations *are* caused by pressure fluctuations in the ion source region.
- These pressure fluctuations are caused by the erroneous response of the mass flow controller when operated with very cold gas that was not allowed to equilibrate to RT.
- The pressure fluctuations are large enough to reach the spark discharge region leading to signal drop outs.

→ Corona discharges are mostly insensitive to the presence of trace constituents present in the ion source

Current work/Outlook

- The presented results are planned to be validated by carefully drying and cleaning of the gases with gas purifiers.
- A new ion source setup for the SCIEX API 3200 series serving as GC-APCI interface which is not susceptible to discharge disruptions, is under construction. H_3^+ is used as primary reagent ion. Highest purity H_2 (>7.0) is obtained from generators.

Literature

1. Chang, J.S.; Lawless, P.A.; Yamamoto, T.; *Corona Discharge Processes*; IEEE Transactions on Plasma Science; 1991; 19(6); 1152-1166.
2. Braekling, S.; *Development of a multiple-corona N_2/H_2 atmospheric pressure ion source for GC-MS*; Masterthesis; university of wuppertal; 2018.
3. Klee, S.; *Charakterisierung und Optimierung von Corona-Mikroplasma initiierten Ionisationsprozessen zur Anwendung in der Atmosphärendruckionisations-Massenspektrometrie*; Dissertation; university of wuppertal; 2014.
4. Shahin, M. M.; *Mass Spectrometric Studies of Corona Discharges in Air at Atmospheric Pressures*; J. Chem. Phys.; 1965; 45; 2600-2605.
5. Dzidic, D.; Carroll, R. N.; Stillwell, Horning, E.C.; *Comparison of Positive Ions Formed in Nickel-63 and Corona Discharge Ion Sources Using Nitrogen, Argon, Isobutane, Ammonia and Nitric Oxide as Reagents in Atmospheric Pressure Ionization Mass Spectrometry*; Anal. Chem. 1976; 48; 1763-1768.

Acknowledgement

Financial and technical support by Sciex (Concord, Canada) is gratefully acknowledged.